

Precision

Water Baths - Shaking, Circulating, Coliform and General Purpose

Manual Part Number U01316, November 5, 2015

Multilingual Quick Start Guides

Installation

Operation

Preventive Maintenance

Troubleshooting



Table of Contents

Quick Start Guides

Preface	P-1
Compliance	P-1
Unpacking	P-1
After-Sale Support	P-1
Feedback.....	P-2
Chapter 1 Safety	1-1
Safety Factors.....	1-1
Chapter 2 General Information	2-1
Description	2-1
Intended Use	2-1
Specifications	2-2
Chapter 3 Installation	3-1
Bath Installation	3-1
Ventilation.....	3-1
Cover Installation	3-1
Electrical Requirements.....	3-2
Approved Fluids	3-3
Filling Requirements.....	3-6
Filling with Thermal Beads.....	3-6
Draining	3-7
Accessories	3-8
Drain Kit Accessory	3-8
Chapter 4 Operation	4-1
Controller.....	4-1
Start Up.....	4-2
Viewing/Changing the Shaker Speed.....	4-3
Changing the Set Point.....	4-3
Selecting a Preset Set Point	4-3
Changing a Setting	4-4
Selecting a Preset.....	4-6
Changing a Preset	4-6
Temperature Display	4-7
Shut Down.....	4-7

Chapter 5	Preventive Maintenance.....	5-1
	Pump Inlet Filter.....	5-1
	Cleaning.....	5-1
	Electrical Power Cord.....	5-2
	Optical Disc.....	5-2
	Shaker Assembly.....	5-2
Chapter 6	Troubleshooting.....	6-1
	Error Displays.....	6-1
	Checklist.....	6-2
Warranty		

Precision Water Bath Quick Start Guide

This quick start guide is intended for initial start up only. For all other procedures you must refer to the manual. Also, if any of these steps are not clear refer to the manual before proceeding.

Filling (Only approved fluids are Filtered/Single Distilled Water and De-ionized Water)

Ensure the reservoir drain port is closed and that all plumbing connections are securely plumbed or capped. Also ensure any residue is thoroughly removed from the reservoir before filling.

To avoid spilling, place your samples/trays into the bath before filling.

Slowly fill the reservoir. When adding, point the opening of a container away from yourself.

For Shaking Water Baths, fill the reservoir with a minimum of one inch of water and the maximum level lower than the tray shaft fitting. Make allowance for water splashing from tray oscillations.

For Circulating and Coliform Baths, fill the reservoir with a minimum of two inches of water, ensuring the suction screen is covered, and a maximum level one inch lower than the upper tank surface.

For GP Baths, fill the reservoir with a minimum of one inch of water and a maximum level one inch lower than the tank upper surface.

Starting

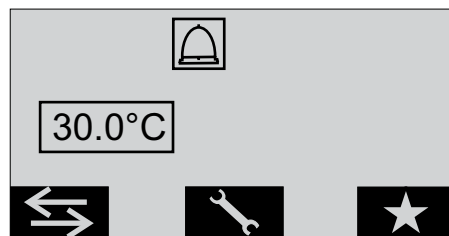

Do not run the bath until fluid is added to the reservoir. Have extra fluid on hand. If the bath does not start refer to the manual.

- Place the circuit protector located on the rear of the bath to the I position.
- The screen will momentarily display **Thermo** SCIENTIFIC and then the home screen appears displaying the set point and the audible alarm status. The set point is the desired reservoir fluid temperature.

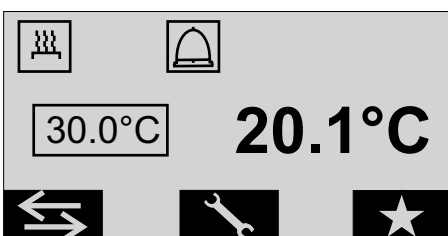

appears on Shaking Water Baths only.



Press  to start the bath and display the fluid temperature. If the reservoir fluid temperature is below the set point the heater  will start.

Viewing/Changing the Shaker Speed (SWB only)

You can view/change the speed value with the bath running or not. From the home screen press the soft key below  to display:

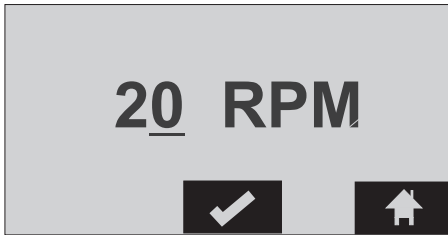



Press, and hold, the arrow keys to bring up the desired value. The values are 0 and 30 to 200. Once the desired value is displayed press  or  to save the change and return to the home screen.

Changing the Set Point (Shaker, Circulating and GP Baths only)

When operating without a lid, limit the maximum set point to 60°C.

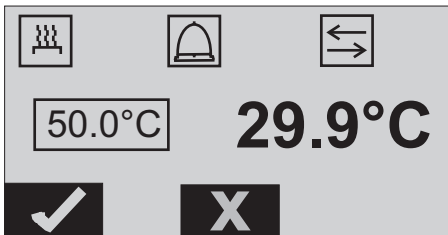
You can change the set point with the bath running or not. From the home screen press either arrow key to display:



Press, and hold, the arrow keys to bring up the desired set point value. The range is 5°C to 100°C. Once the desired value is displayed, in this case 50.0°C, press the soft key below  to save the change or press the soft key below  to not save the change. The display returns to the home screen.

Note After a 30 second delay if neither key is pressed the display returns to the home screen, any change is not saved.

Selecting a Preset

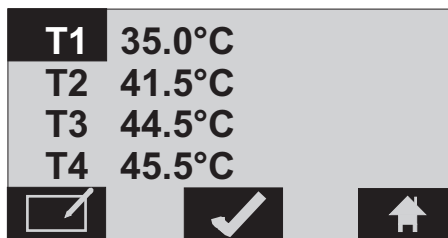

You can select a preset with the bath running or not.

From the home screen press  :

Use the arrow keys to select the desired preset. Once the desired preset is highlighted press the soft key below  to save the change and return to the home screen.

Note After a 30 second delay if neither key is pressed the display returns to the home screen, any change is not saved.

From the home screen you can cycle through the set points by pressing the arrow keys (Coliform baths only).

Kurzanleitung zur Inbetriebnahme des Präzisionswasserbades

Diese Kurzanleitung ist nur für die erste Inbetriebnahme vorgesehen. Für alle anderen Verfahren müssen Sie im Handbuch nachsehen. Auch wenn irgendwelche Schritte unklar sind, schaue Sie im Handbuch nach, bevor Sie fortfahren.

Befüllung

Stellen Sie sicher, dass der Ablauf des Behälters geschlossen ist und dass alle Anschlüsse sicher angeschlossen oder verschlossen sind. Achten Sie außerdem darauf, dass vor dem Befüllen des Behälters alle Rückstände gründlich entfernt wurden.

Um ein Überlaufen zu vermeiden, stellen Sie die zu temperierenden Proben/Tablets vor dem Befüllen in das Bad.

Füllen Sie den Behälter langsam. Halten Sie den Behälter beim Einfüllen so, dass seine Öffnung von Ihnen weg zeigt.

Füllen Sie bei Rüttel-Wasserbädern den Behälter mindestens bis zu einer Füllhöhe von 2,5 cm mit Wasser, und höchstens bis unterhalb der Halterung für den Tablettenschaft. Lassen Sie etwas Platz für Spritzwasser durch die Schwingungen des Tablets.

Für zirkulierende Bäder und Bäder für Coliforme Anwendungen füllen Sie den Behälter bis zu einer Füllhöhe von mindestens 5 Zentimetern mit Wasser, und achten Sie dabei darauf, dass das Ansauggitter bedeckt ist, und bis maximal 2,5 cm unterhalb des Flüssigkeitsstandes im oberen Tank.

Für GP-Bäder füllen Sie den Behälter mindestens bis zu einer Füllhöhe von 2,5 cm mit Wasser, und bis maximal 2,5 cm unterhalb des Flüssigkeitsstandes im oberen Tank.

Starten

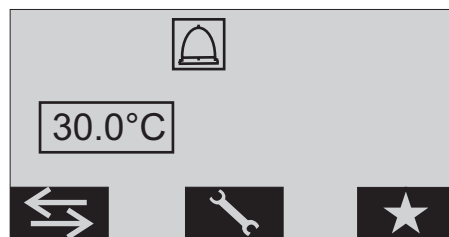

Lassen Sie das Gerät erst laufen, nachdem Sie die Badflüssigkeit hinzugegeben haben. Halten Sie zusätzliche Flüssigkeit griffbereit. Wenn das Gerät nicht startet, sehen Sie im Handbuch nach.

- Stellen Sie den Schalter an der Rückseite des Bades auf die Position I.
- Der Bildschirm geht sofort an **Thermo** SCIENTIFIC, dann erscheint der Einstiegsbildschirm mit dem Sollwert und einem akustischen Statusalarm. Der Sollwert ist die gewünschte Temperatur der Behälterflüssigkeit.

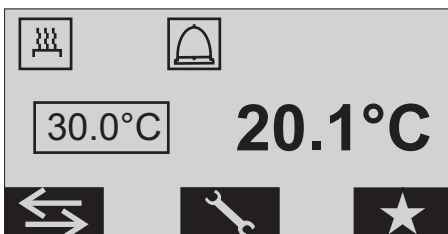

erscheint nur an Rüttel-
Wasserbädern.





Drücken Sie  zum Starten des Bades und zur Anzeige der Flüssigkeitstemperatur. Liegt die Temperatur der Flüssigkeit im Behälter unterhalb der Sollwerttemperatur, so wird die Heizung  eingeschaltet.

Anzeigen/ändern der Rüttelgeschwindigkeit (nur SWB)

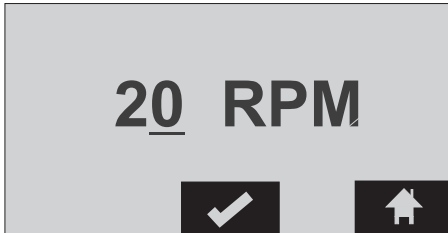
Die Geschwindigkeitseinstellung lässt sich sowohl bei eingeschaltetem als auch bei ausgeschaltetem Bad anzeigen/ändern. Vom Einstiegsbildschirm aus drücken Sie die Schaltfläche unten  zur Anzeige von:





Drücken Sie die Pfeiltasten, und halten Sie diese gedrückt, bis der gewünschte Wert erscheint. Die Werte sind 0 und 30 bis 200. Wird der gewünschte Wert angezeigt, drücken Sie  oder , um die Änderung zu speichern und zum Einstiegsbildschirm zurückzukehren.

Ändern des Sollwertes (nur Rüttel-, Zirkulations- und GP-Bäder)

Beim Betrieb ohne Abdeckung ist der Sollwert auf maximal 60 °C zu begrenzen.

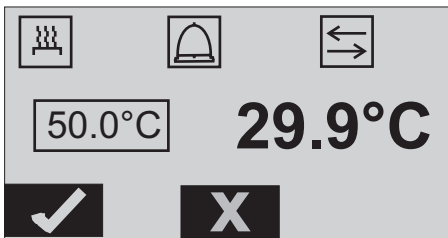
Sie können den Sollwert ändern, gleichgültig, ob das Bad läuft oder nicht. Vom Einstiegsbildschirm aus drücken Sie eine der beiden Pfeiltasten zur Anzeige von:



Drücken Sie die Pfeiltasten und halten Sie diese gedrückt, bis der gewünschte Sollwert erscheint. Der Temperaturbereich reicht von 5 °C bis 100 °C. Wird der gewünschte Wert angezeigt, in diesem Fall 50,0 °C, so drücken Sie die Schaltfläche unten , um die Änderung zu speichern, oder drücken Sie die Schaltfläche unten , um die Änderung nicht abzuspeichern.

Die Anzeige kehrt zum Einstiegsbildschirm zurück. Beachten Sie bitte, dass nach einer Verzögerung von 30 Sekunden, wenn keine der beiden Tasten gedrückt wird, die Anzeige zum Einstiegsbildschirm zurückkehrt. Änderungen werden dann nicht gespeichert.

Auswahl eines voreingestellten Sollwertes

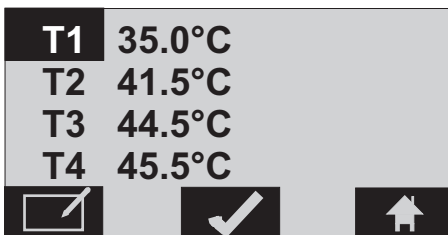

Sie können den voreingestellten Sollwert auswählen, gleichgültig, ob das Bad läuft oder nicht.

Vom Einstiegsbildschirm aus drücken Sie  :

Verwenden Sie bitte die Pfeiltasten zur Auswahl des gewünschten Sollwertes. Sobald der gewünschte Sollwert erscheint, drücken Sie bitte die Schaltfläche unten , um die Änderung zu speichern und zum Einstiegsbildschirm zurückzukehren.

Beachten Sie bitte dass nach einer Verzögerung von 30 Sekunden, wenn keine der beiden Tasten gedrückt wird, die Anzeige zum Einstiegsbildschirm zurückkehrt. Änderungen werden dann nicht gespeichert.

Vom Einstiegsbildschirm aus können Sie durch die Sollwerte rollieren, indem Sie die Pfeiltasten drücken (nur für Bäder für Coliforme Anwendungen).

Guide de démarrage rapide - Bain de précision

Ce guide de démarrage rapide est destiné à la mise en marche initiale uniquement. Pour toute autre procédure, merci de vous référer au manuel. De plus, si l'une de ses étapes ne vous paraît pas claire, téléchargez le manuel avant de commencer.

Remplissage

Assurez-vous que le port de vidange du réservoir est fermé et que tous les tuyaux sont soit branchés, soit rebouchés. Vérifiez également qu'il ne reste plus aucun résidu dans le réservoir avant de le remplir.

Pour éviter les éclaboussures, placez les échantillons/plateaux dans le bain avant de remplir ce dernier.

Remplissez lentement le réservoir en maintenant l'ouverture du conteneur à distance.

Pour les bains à agitation, remplissez le réservoir d'au moins 2,5 centimètres (1 pouce) d'eau et assurez-vous que le niveau maximum est inférieur à celui de la pièce d'entraînement du plateau. Prenez en compte les éclaboussures dues aux oscillations du plateau.

Pour les bains à circulation et coliformes, remplissez le réservoir d'au moins 5 centimètres (2 pouces) d'eau, en faisant en sorte de recouvrir l'écran d'aspiration. Le niveau maximum doit se trouver 2,5 centimètres (1 pouce) en dessous de la surface du réservoir supérieur.

Pour les bains GP, remplissez le réservoir d'au moins 2,5 centimètres (1 pouce) d'eau et assurez-vous que le niveau maximum se trouve 2,5 centimètres (1 pouce) en dessous de la surface du réservoir supérieur.

Démarrage

Ne faites pas fonctionner le bain tant que le réservoir ne contient pas de liquide. Conservez une quantité de liquide supplémentaire à proximité. Si le bain ne démarre pas, reportez-vous au manuel.

- Placez le dispositif de protection des circuits situé à l'arrière du bain sur la position **I**.

• **Thermo** s'affichera momentanément à l'écran, puis l'écran d'accueil s'affiche et indique la température définie et le statut de l'alarme sonore. La température définie correspond à la température souhaitée pour le liquide contenu dans le réservoir.

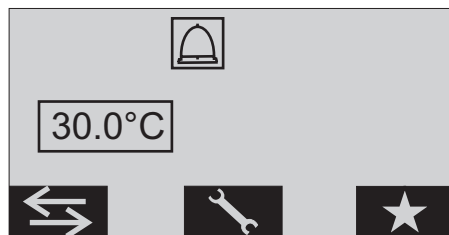

s'affiche pour les bains à agitation uniquement.

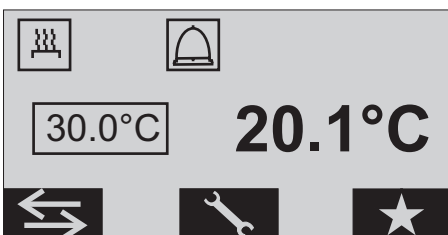

Appuyez sur  pour démarrer le bain et afficher la température du liquide.



Si la température du liquide se trouvant dans le réservoir est inférieure à la température définie, le réchauffeur  se met en marche.

Affichage/modification de la vitesse d'agitation (SWB uniquement)

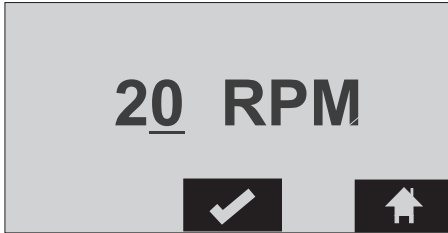
Vous avez la possibilité d'afficher/de modifier la vitesse, que le bain soit en cours d'utilisation ou non. À l'écran d'accueil, appuyez sur la touche se trouvant sous  pour afficher :



Appuyez sur les touches flèche et maintenez-les enfoncées jusqu'à atteindre la valeur désirée. Les valeurs sont 0 et de 30 à 200.



Une fois que la valeur désirée est affichée, appuyez sur  ou  pour enregistrer la modification et revenir à l'écran d'accueil.

Modification de la température définie (bains à agitation, circulation et GP uniquement)

Si vous utilisez le bain sans couvercle, définissez la température maximum à 60 °C.

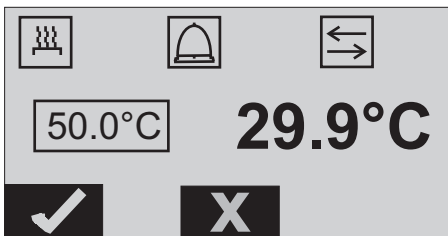
Vous pouvez modifier la température définie que le bain soit ou non en cours d'utilisation. À l'écran d'accueil, appuyez sur une touche flèche pour afficher :



Appuyez sur les touches flèche et maintenez-les enfoncées jusqu'à atteindre la valeur de température définie désirée. La plage de valeurs va de 5 °C à 100 °C. Une fois que la valeur désirée est affichée, dans ce cas 50 °C, appuyez sur la touche se trouvant sous  pour enregistrer la modification ou sur la touche sous  pour ne pas enregistrer la modification. L'affichage retourne à l'écran d'accueil.

Remarque Au bout de 30 secondes, si vous n'avez appuyé sur aucune de ces deux touches, l'affichage retourne à l'écran d'accueil et les modifications effectuées, le cas échéant, ne sont pas sauvegardées.

Sélection d'une température prédéfinie

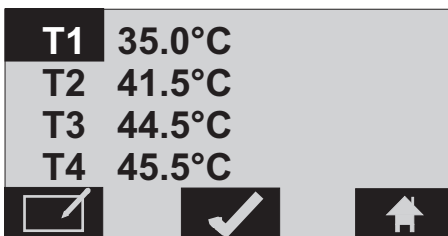

Vous pouvez sélectionner une température prédéfinie, que le bain soit ou non en cours d'utilisation.

À l'écran d'accueil, appuyez sur  :

Utilisez les touches flèche pour sélectionner la valeur de température définie désirée. Une fois la valeur désirée en surbrillance, appuyez sur la touche se trouvant sous  pour enregistrer la modification et retourner à l'écran d'accueil.

Remarque Au bout de 30 secondes, si vous n'avez appuyé sur aucune de ces deux touches, l'affichage retourne à l'écran d'accueil et les modifications effectuées, le cas échéant, ne sont pas sauvegardées.

Vous pouvez faire défiler les températures définies à l'écran d'accueil en utilisant les touches flèche (bains coliformes uniquement).

Guía de inicio rápido de bañeras de agua de precisión

Esta guía de inicio rápido se ha creado únicamente para el arranque inicial. Para obtener información sobre el resto de procedimientos, debe consultar el manual. Asimismo, en caso de que tuviera dudas sobre alguno de estos pasos, consulte el manual antes de continuar.

Llenado

Asegúrese de que el puerto de drenaje del depósito está cerrado y de que todas las conexiones de tuberías se han conectado y tapado correctamente. Asimismo, asegúrese de que se han eliminado todos los residuos del depósito antes de proceder al llenado.

Para evitar salpicaduras, introduzca las muestras/bandejas en la bañera antes de llenarla.

Llene el depósito lentamente. Al añadir agua, coloque la apertura de un contenedor lejos de usted.

En el caso de bañeras de agua con agitación, llene el depósito con una cantidad mínima equivalente a dos centímetros y medio de agua y un nivel máximo que sea inferior al ajuste del eje de la bandeja. Tenga en cuenta las salpicaduras de agua procedentes de las oscilaciones de la bandeja.

En el caso de bañeras circuladoras y coliformes, llene el depósito con un mínimo de cinco centímetros de agua, cubriendo la pantalla de succión, y un nivel máximo que sea de dos centímetros y medio por debajo de la superficie superior del tanque.

En el caso de bañeras GP, llene el depósito con un mínimo de dos centímetros y medio de agua y un nivel máximo de dos centímetros y medio por debajo de la superficie superior del tanque.

Puesta en marcha

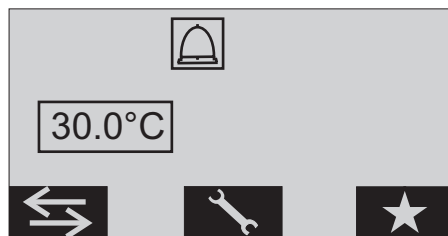
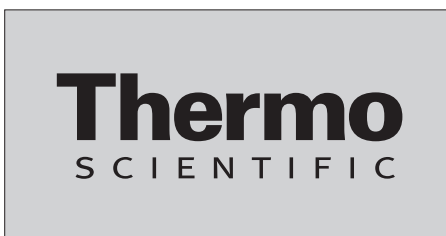

No ponga en marcha la bañera hasta que se haya añadido líquido al depósito. Tenga a mano algo de líquido adicional. Si la unidad no llegara a ponerse en marcha, consulte el manual.

- Coloque el protector de circuitos, situado en la parte posterior de la bañera, en la posición **I**.
- La pantalla aparecerá momentáneamente **Thermo** SCIENTIFIC y, a continuación, aparecerá la pantalla de inicio mostrando el punto de ajuste y el estado de la alarma audible. El punto de ajuste es la temperatura deseada del fluido del depósito.

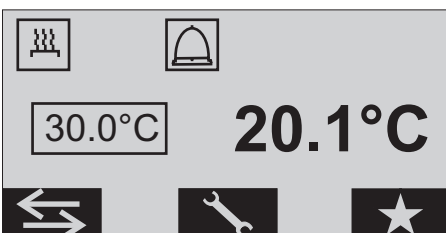

solo aparece en  bañeras de agua con agitación.





Pulse  para poner en marcha la bañera y mostrar la temperatura del fluido. Si la temperatura del fluido del depósito está por debajo del punto de ajuste, se pondrá en marcha el calentador .

Visualización/modificación de la velocidad del agitador (solo SWB)

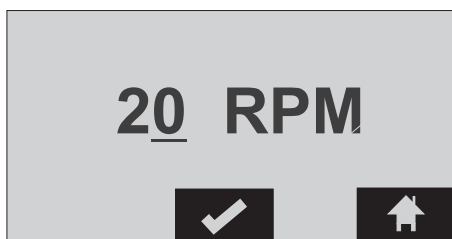
Puede ver/modificar el valor de la velocidad con la bañera en marcha o parada. En la pantalla de inicio, pulse la siguiente tecla multifunción  para mostrar:



Pulse y mantenga pulsadas las teclas de flecha para que aparezca el valor deseado. Los valores pueden ser 0 y de 30 a 200.

Una vez que aparezca el valor deseado, pulse  o  para guardar los cambios y volver a la pantalla de inicio.



Modificación del punto de ajuste (solo bañeras con agitador, circuladoras y GP)

Cuando se opere sin tapa, limite el punto de ajuste máximo a 60 °C.

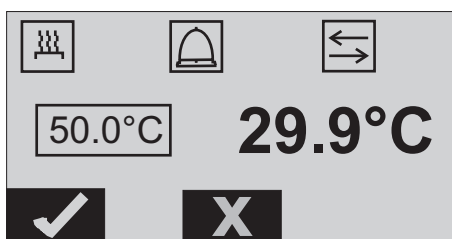
Puede cambiar el punto de ajuste con la bañera en marcha o parada.



En la pantalla de inicio, pulse cualquier tecla de flecha para mostrar:

Pulse y mantenga pulsadas las teclas de flecha para que aparezca el valor del punto de ajuste deseado. El rango se encuentra comprendido entre 5 °C y 100 °C. Una vez que aparezca el valor deseado, en este caso 50 °C, pulse la siguiente tecla multifunción  para guardar los cambios, o pulse la siguiente tecla multifunción  para no guardarlos. El visualizador vuelve a la pantalla de inicio.

Nota Una vez transcurridos 30 segundos, y si el visualizador vuelve a la pantalla de inicio si no se pulsa ninguna tecla, no se guarda ningún cambio.

Selección de un punto de ajuste predeterminado

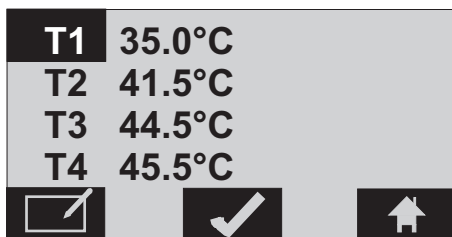

Puede seleccionar un punto de ajuste predeterminado con la bañera en marcha o parada.

En la pantalla de inicio, pulse :

Utilice las teclas de flecha para seleccionar el valor del punto de ajuste deseado. Una vez que aparezca resaltado el punto de ajuste, pulse la siguiente tecla multifunción  para guardar los cambios y volver a la pantalla de inicio.

Nota Una vez transcurridos 30 segundos, y si el visualizador vuelve a la pantalla de inicio si no se pulsa ninguna tecla, [3]no[4] se guarda ningún cambio.

En la pantalla de inicio, puede pasar por los puntos de ajuste pulsando las teclas de flecha (solo en el caso de bañeras coliformes).

Banho de água de precisão – Guia de início rápido

Este guia de início rápido destina-se apenas ao arranque inicial. Para todos os outros procedimentos, consulte o manual. Além disso, se qualquer uma dessas etapas não estiver clara, consulte o manual antes de prosseguir.

Preenchimento

Certifique-se de que a porta de drenagem do reservatório esteja fechada e que todas as conexões do encanamento estejam firmemente sondadas ou tampadas. Também garanta que qualquer resíduo seja cuidadosamente removido do reservatório antes do preenchimento.

Para evitar o derramamento, coloque as amostras/bandejas no banho antes do enchimento.

Encha lentamente o reservatório.

Enquanto adiciona, aponte a abertura do recipiente para longe de você. Para banhos de água agitados, encha o reservatório com, no mínimo, uma polegada de água e o nível máximo mais baixo que a conexão do eixo da bandeja. Deixe uma folga para respingos de água durante as oscilações da bandeja.

Para banhos de circulação e coliformes, encha o reservatório com, no mínimo, duas polegadas de água, assegurando que o crivo de aspiração esteja coberto, e um nível máximo de uma polegada por baixo da superfície superior do tanque.

Para Banhos GP, encha o reservatório com, no mínimo, uma polegada de água e um máximo nível de uma polegada por baixo da superfície superior do tanque.

Iniciando

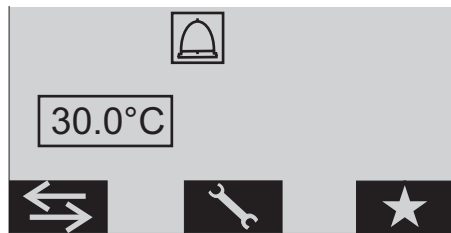
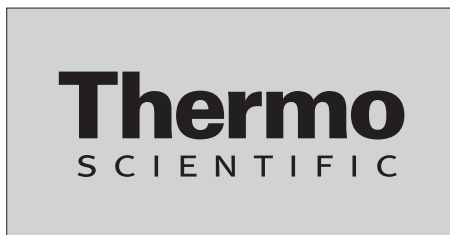

Não execute o banho até que o fluido seja adicionado ao reservatório. Tenha fluido adicional em mãos. Se o banho não começar, consulte o manual.

- Mova o protetor de circuito, localizado na parte traseira do banho, para a posição **I**.
- A tela irá exibir momentaneamente **Thermo** SCIENTIFIC e, em seguida, a tela inicial aparecerá exibindo o ponto de ajuste e o status do alarme sonoro. O ponto de ajuste é a temperatura desejada do fluido do reservatório.

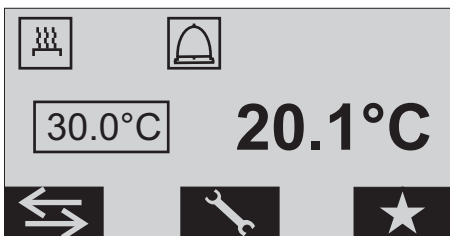

aparece somente em  Banhos de água agitados.



Pressione  para iniciar o banho e exibir a temperatura do fluido. Se a temperatura do fluido do reservatório estiver abaixo do ponto de ajuste, o aquecedor  será iniciado.

Visualizar/alterar a velocidade do agitador (apenas SWB)

Você pode visualizar/alterar a velocidade com o banho funcionando ou parado. Na tela inicial, pressione a tecla de função abaixo para exibir:

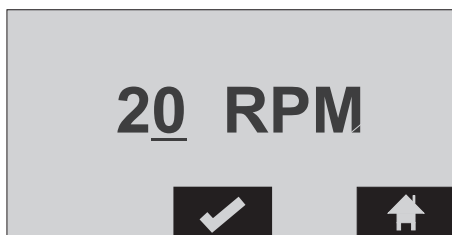

Pressione e segure as teclas de seta para exibir o valor desejado.

Os valores são 0 e 30 a 200. Quando o valor desejado for exibido, pressione



ou



para salvar a alteração e voltar à tela inicial.

Alterar o Ponto de ajuste (apenas para banho agitado, circulação e GP)

Ao operar sem tampa, limite o ponto máximo definido para 60 °C.

Você pode alterar o ponto de ajuste com o banho funcionando ou parado. A partir da tela inicial, pressione qualquer tecla de seta para exibir:

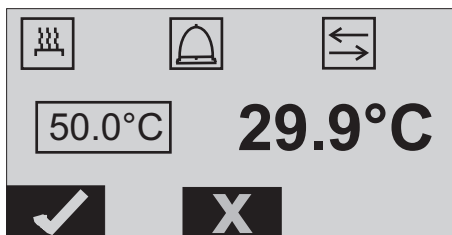

Pressione e segure as teclas de seta para mostrar o valor de ajuste desejado. A variação é de 5 °C a 100 °C. Quando o valor desejado for exibido, neste caso, 50 °C, pressione a tecla programável abaixo para salvar a alteração ou pressione a tecla programável abaixo para não salvar a alteração. A tela retorna à tela inicial.

Nota Depois de um intervalo de 30 segundos, se nenhuma tecla for pressionada, a tela retornará para a tela inicial, e as alterações não serão salvas.

Seleção de um ponto de ajuste pré-definido

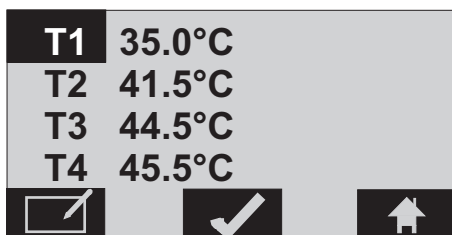

Você pode selecionar um ponto de ajuste pré-definido com o banho funcionando ou parado.

A partir da tela inicial, pressione



Use as setas de seta para selecionar o valor de ponto de ajuste desejado.

Quando o ponto de ajuste desejado estiver realçado, pressione a tecla programável abaixo



para salvar a alteração e voltar à tela inicial.

Nota Depois de um intervalo de 30 segundos, se nenhuma tecla for pressionada, a tela retornará para a tela inicial, e as alterações não serão salvas.

A partir da tela inicial, você pode percorrer os pontos de ajuste pressionando as teclas de seta (apenas banhos de coliformes).

Preface

Compliance

The Declaration of Conformity is available upon request.

Unpacking

The bath is supplied with an electrical power cord. Do not discard the packaging until the cord is located and the bath is operating.

If the bath shows external or internal damage contact the transportation company and file a damage claim. Under ICC regulations, this is your responsibility.



The bath does not have handles. Take into account its weight when unpacking and transporting. We recommend two people lift heavier baths from the bottom.

After-sale Support

Thermo Fisher Scientific is committed to customer service both during and after the sale. If you have questions concerning the bath operation, or questions concerning spare parts or Service Contracts, call our Sales, Service and Customer Support phone number, see next page for contact information.

Before calling, please obtain the following information:

- bath model number
- bath serial number
- power source voltage

The model and serial number are located on its nameplate label on the rear of the bath.

Feedback

We appreciate any feedback you can give us on this manual. Please e-mail us at:

tcmanuals@thermofisher.com

Please include the manual part number and the revision date listed on the front cover.

Thermo Fisher Scientific

25 Nimble Hill Road
Newington, NH 03801
Tel : (800) 258-0830 or
(603) 436-9444
Fax : (603) 436-8411
www.thermoscientific.com/tc

Sales, Service, and Customer Support

25 Nimble Hill Road
Newington, NH 03801
Tel: (800) 258-0830
Sales: 8:00 am to 5:00 pm
Service and Support: 8:00 am to 6:00 pm
Monday through Friday (Eastern Time)
Fax: (603) 436-8411
service.tc.us@thermofisher.com



Chapter 1 Safety

Safety Factors

Make sure you read and understand all instructions and safety precautions listed in this manual before installing or operating your bath. If you have any questions concerning the operation of your bath or the information in this manual, please contact us.

There are no special personal protective equipment requirements needed to perform normal operation. We do recommend always wearing eye protection and gloves.



DANGER indicates an imminently hazardous situation which, if not avoided, will result in death or serious injury.



WARNING indicates a potentially hazardous situation which, if not avoided, could result in death or serious injury.



CAUTION indicates a potentially hazardous situation which, if not avoided, may result in minor or moderate injury. It is also used to alert against unsafe practices.



The lightning flash with arrow symbol, within an equilateral triangle, is intended to alert the user to the presence of non-insulated "dangerous voltage" within the bath's enclosure. The voltage magnitude is significant enough to constitute a risk of electrical shock.



This label indicates the presence of hot surfaces.



This label indicates read the manual.



This label indicates a hand crushing hazard. (Shaking Water Bath only)

Observe all warning labels.

Never remove warning labels.

The bath's construction provides protection against the risk of electrical shock by grounding appropriate metal parts. The protection will not function unless the power cord is connected to a properly grounded outlet. It is the user's responsibility to assure a proper ground connection is provided.

Do not use the bath as a sterile or patient connected device. In addition, the bath is not designed for use in Class I, II or III locations as defined by the National Electrical Code.

The circuit protector located on the rear of the bath is not intended to act as a disconnecting means. The bath's power cord is used as the disconnecting device, it must be easily accessible at all times.

Never operate the bath with a damaged line cord.

Never place the bath in a location or atmosphere where excessive heat, moisture, or corrosive materials are present.

Never operate the bath without fluid in the reservoir. The only approved fluids are filtered/single distilled water and de-ionized water. General Purpose Baths may also use thermal beads.

Never operate the bath or add fluid to the reservoir with panels removed.

Operating the baths at high temperature will cause condensation on the underside of the cover. Remove the cover with care so the water falls back into the reservoir and not on the bath surface.

When operating at high temperatures do not touch the cover surface, always use the cover's knob/handle.

The user is responsible for any hazard rising from heated material.

Do not clean the bath with solvents, only use a soft cloth and water.

Drain the bath before it is moved. Drain the bath before it is transported and/or stored. Store the bath in the temperature range -25°C to 60°C (with packaging), and <80% relative humidity.

Always turn the bath off and disconnect the supply voltage from its power source before moving the bath or before performing any service or maintenance procedures.

Transport the bath with care. Sudden jolts or drops can damage its components.

An operating shaking bath has moving components. Do not insert appendages between the reservoir wall and rack. We recommend stopping the shaker table when loading/removing samples or vessels.

Refer service and repairs to a qualified technician.

Performance of installation, operation, or maintenance procedures other than the ones described in this manual may result in a hazardous situation and will void the manufacturer's warranty.

2

Chapter 2 General Information

Description

All Thermo Scientific™ Precision Water Baths provide constant temperature to applications placed in the reservoir. All have digital displays, four programmable set point temperatures, acoustic and optical alarms, and offer adjustable high temperature protection.

The interior of the bath is constructed of stainless steel and is designed for operation with water. The body is made from galvanized steel and is painted for added protection.

The nameplate label on the bath identifies its electrical requirements.

Intended Use

The baths are intended for use in research and quality control.

They are intended for use by a qualified lab technician trained in basic laboratory procedures and safety protocols. Also, for indoor use in a laboratory environment on a bench top only.

Shaking Water Bath Specifications

	SWB 15/SWB 15S/DUB 15	SWB 27
Reservoir Fluid Control Temperature °C °F	Ambient +5 to 100 Ambient +9 to 212	
Set Point Temperature Range °C °F	+5 to 100 +9 to 212	
Ambient Temperature Range °C °F	+15 to 45 +59 to 113	
Stability/Uniformity @ 37°C	±0.1/±0.05	
Heating Output watts	1200	1500
Bath Volume liters	15	27
Overall Bath Dimensions (L x W x H) cm inches	39.4 x 63.2 x 24.9 15.5 x 24.9 x 9.8	39.4 x 93.8 x 24.9 15.5 x 36.9 x 9.8
Bath Work Area Dimensions (L x W x H) cm inches	29.2 x 30.5 x 16.5 11.5 x 12.0 x 6.5	29.2 x 61.0 x 16.5 11.5 x 24.0 x 6.5
Tray Dimensions (L x W x H) cm inches	28.9 x 30.8 x 14.8 11.3 x 12.1 x 5.8	28.9 x 61.5 x 14.8 11.3 x 24.2 x 5.8
Tray Depth cm inches	8.9 3.5	
Shaking Speed rpm	0 and 30 - 200	
Stroke Length mm	26	
Max Tray Load kg lb	9 20	14 30
Approximate Weight kg lb	22 48	27 62
Electrical Requirements (VAC/Hz) (Voltage ±10%)	100-115/50-60 or 200-230/50-60	
Compliance	CE RoHS UL WEEE	
Maximum Relative Humidity (Non Condensing)	80% (up to 31°C) 80% (up to 88°F)	
Operating Altitude meters feet	Sea Level to 2000 Sea Level to 6560	
Overvoltage Category	II	
Pollution Degree	2	
Storage Temperature Range °C °F	-25 to +60 -13 to +140	

Low-end temperatures require supplemental cooling.

Specifications obtained at sea level using water.

Bath depth includes bezel, height does not include lid.

Thermo Fisher Scientific takes no responsibility for damages caused by the selection of an unapproved fluids.

Thermo Fisher Scientific reserves the right to change specifications without notice.

Circulating Bath Specifications

	CIR 19	CIR 35	CIR 89
Reservoir Fluid Control Temperature °C °F	Ambient +5 to 100 Ambient +9 to 212		
Set Point Temperature Range °C °F	+5 to 100 +9 to 212		
Ambient Temperature Range °C °F	+15 to 45 +59 to 113		
Stability @ 37°C	±0.1		
Uniformity @ 37°C	±0.05	±0.05	±0.1
Heating Output watts	1200	1500	1500
Bath Volume liters	19	35	89
Overall Bath Dimensions (L x W x H) cm inches	39.4 x 63.2 x 24.9 15.5 x 24.9 x 9.8	39.4 x 93.8 x 24.9 15.5 x 36.9 x 9.8	54.6 x 116.0 x 30.0 21.5 x 45.7 x 11.8
Bath Work Area Dimensions (L x W x H) cm inches	30.5 x 38.7 x 19.2 12.0 x 15.3 x 7.6	30.5 x 69.2 x 19.2 12.0 x 27.3 x 7.6	48.3 x 91.4 x 24.1 19.0 x 36.0 x 9.5
Approximate Weight kg lb	20 45	31 68	38 85
Electrical Requirements (VAC/Hz) (Voltage ±10%)	100-115/50-60 or 200-230/50-60		
Pump Pressure mbar	262		
Pump Flow lpm	10.6		
Compliance	CE RoHS UL WEEE		
Maximum Relative Humidity (Non Condensing)	80% (up to 31°C) 80% (up to 88°F)		
Operating Altitude meters feet	Sea Level to 2000 Sea Level to 6560		
Overvoltage Category	II		
Pollution Degree	2		
Storage Temperature Range °C °F	-25 to +60 -13 to +140		

Low-end temperatures require supplemental cooling.

Specifications obtained at sea level using water.

Bath depth includes bezel, height does not include lid.

Thermo Fisher Scientific takes no responsibility for damages caused by the selection of an unapproved fluids.

Thermo Fisher Scientific reserves the right to change specifications without notice.

General Purpose Water Bath Specifications

	GP 02	GP 2S	GP 05	GP 10
Reservoir Fluid Control Temperature °C °F	Ambient to 90 Ambient to 194	Ambient to 100 Ambient to 212		
Set Point Temperature Range °C °F	+5 to 100 +9 to 212			
Ambient Temperature Range °C °F	+15 to 45 +59 to 113			
Stability @ 37°C	±0.1			
Uniformity @ 37°C	±0.2			
Heating Output watts	200	300	300	800
Bath Volume liters	2	2	5	10
Overall Bath Dimensions (L x W x H) cm inches	23.0 x 19.9 x 23.3 9.1 x 7.8 x 9.2	24.6 x 35.5 x 23.2 9.7 x 14.0 x 9.1	24.6 x 35.5 x 23.2 9.7 x 14.0 x 9.1	39.3 x 38.3 x 23.3 15.5 x 15.1 x 9.2
Bath Work Area Dimensions (L x W x H) cm inches	13.8 x 15.5 x 15.0 5.4 x 6.1 x 5.9	15.3 x 30.0 x 6.5 6.0 x 11.8 x 2.6	15.4 x 30.0 x 15.0 6.1 x 11.8 x 5.9	30.1 x 33.0 x 15.0 11.9 x 13.0 x 5.9
Approximate Weight kg lb	3.5 7	4 9	4.5 10	7.5 16
Electrical Requirements (VAC/Hz) (Voltage ±10%)	100-115/50-60 or 200-230/50-60			
Compliance	CE RoHS UL WEEE			
Maximum Relative Humidity (Non Condensing)	80% (up to 31°C) 80% (up to 88°F)			
Operating Altitude meters feet	Sea Level to 2000 Sea Level to 6560			
Overvoltage Category	II			
Pollution Degree	2			
Storage Temperature Range °C °F	-25 to +60 -13 to +140			

Low-end temperatures require supplemental cooling.

Specifications obtained at sea level using water.

Thermal beads may be used instead of water but they will degrade the bath's uniformity and stability.

Bath depth includes bezel, height does not include lid.

Thermo Fisher Scientific takes no responsibility for damages caused by the selection of an unapproved fluids.

Thermo Fisher Scientific reserves the right to change specifications without notice.

General Purpose Water Bath Specifications

	GP 20	GP 28	GP 15D
Reservoir Fluid Control Temperature °C °F	Ambient to 100 Ambient to 212		
Set Point Temperature Range °C °F	+5 to 100 +9 to 212		
Ambient Temperature Range °C °F	+15 to 45 +59 to 113		
Stability @ 37°C	±0.1		
Uniformity @ 37°C	±0.2		
Heating Output watts	1200	1200	300 and 800
Bath Volume liters	20	28	5 and 10
Overall Bath Dimensions (L x W x H) cm inches	39.2 x 55.5 x 23.3 15.4 x 21.8 x 9.2	39.2 x 55.5 x 28.2 15.4 x 21.8 x 11.1	39.2 x 58.7 x 23.3 15.4 x 23.1 x 9.2
Bath Work Area Dimensions (L x W x H) cm inches	29.7 x 50.0 x 15.0 11.7 x 19.7 x 5.9	29.7 x 50.0 x 20.0 11.7 x 19.7 x 7.9	See GP 05 and GP 10
Approximate Weight kg lb	10 22	12 26	TBD TBD
Electrical Requirements (VAC/Hz) (Voltage ±10%)	100-115/50-60 or 200-230/50-60		
Compliance	CE RoHS UL WEEE		
Maximum Relative Humidity (Non Condensing)	80% (up to 31°C) 80% (up to 88°F)		
Operating Altitude meters feet	Sea Level to 2000 Sea Level to 6560		
Overvoltage Category	II		
Pollution Degree	2		
Storage Temperature Range °C °F	-25 to +60 -13 to +140		

Low-end temperatures require supplemental cooling.

Specifications obtained at sea level using water.

Thermal beads may be used instead of water but they will degrade the bath's uniformity and stability.

Bath depth includes bezel, height does not include lid.

Thermo Fisher Scientific takes no responsibility for damages caused by the selection of an unapproved fluids.

Thermo Fisher Scientific reserves the right to change specifications without notice.

Coliform Bath Specifications

	COL 19	COL 35
Reservoir Fluid Set Point Temperatures °C °F	35.0, 41.5, 44.5, 45.5 95.0, 106.7, 112.1, 113.9	
Ambient Temperature Range °C °F	+15 to 45 +59 to 113	
Stability @ 37°C	±0.1	
Uniformity @ 37°C	±0.05	
Heating Output watts	1200	1500
Bath Volume liters	19	35
Overall Bath Dimensions (L x W x H) cm inches	39.4 x 63.2 x 24.9 15.5 x 24.9 x 9.8	39.4 x 93.8 x 24.9 15.5 x 36.9 x 9.8
Bath Work Area Dimensions (L x W x H) cm inches	30.5 x 38.7 x 19.2 12.0 x 15.3 x 7.6	30.5 x 69.2 x 19.2 12.0 x 27.3 x 7.6
Approximate Weight kg lb	16 35	27 60
Electrical Requirements (VAC/Hz) (Voltage ±10%)	100-115/50-60 or 200-230/50-60	
Pump Pressure mbar	262	
Pump Flow lpm	10.6	
Compliance	CE RoHS UL WEEE	
Maximum Relative Humidity (Non Condensing)	80% (up to 31°C) 80% (up to 88°F)	
Operating Altitude meters feet	Sea Level to 2000 Sea Level to 6560	
Overvoltage Category	II	
Pollution Degree	2	
Storage Temperature Range °C °F	-25 to +60 -13 to +140	

Specifications obtained at sea level using water.

Bath depth includes bezel, height does not include lid.

Thermo Fisher Scientific takes no responsibility for damages caused by the selection of an unapproved fluids.

Thermo Fisher Scientific reserves the right to change specifications without notice.

3

Chapter 3 Installation

Bath Installation

The bath is designed for continuous operation and for indoor use.



Never place the bath in a location where excessive heat, moisture or corrosive materials are present.

For shaking water baths, the installation platform must be capable of withstanding the shaking generated when the bath is in operation.

Ventilation

No special ventilation clearances are required.

Cover Installation

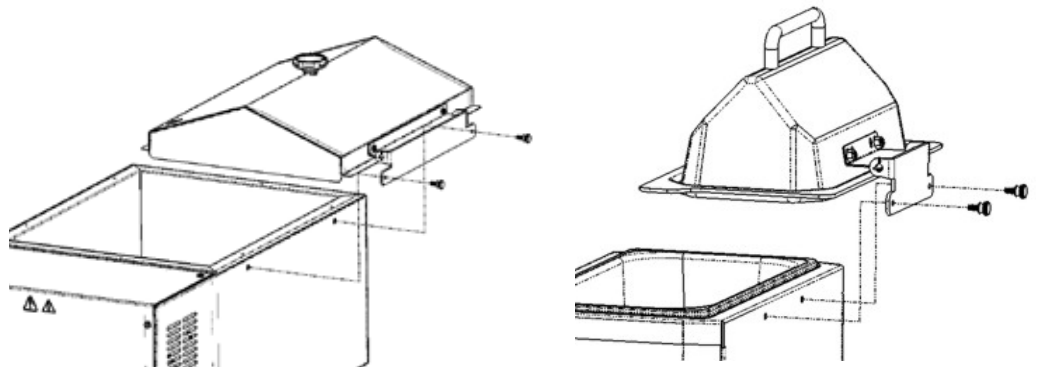

Figure 3-1 – Shaking and Circulating Bath Cover Installation, GP Bath Cover Installation

Electrical Requirements

Refer to the bath's nameplate for specific electrical requirements.

The bath is intended for use on a dedicated outlet.



The bath construction provides protection against the risk of electrical shock by grounding appropriate metal parts. The protection will not function unless the power cord is connected to a properly grounded outlet. It is the user's responsibility to assure a proper ground connection is provided.

The circuit protector on the rear of the bath is designed to protect the bath's internal components.

Note If the circuit protector activates allow the temperature to cool before resetting. Restart the bath. Contact us if the circuit protector activates again.



The bath's electrical power cord is the disconnecting device, it must be easily accessible at all times.



Ensure the cord does not come in contact with the reservoir contents.

Note Before inserting the electrical cord into the bath connection ensure the circuit protector is in the **O** (off) position.

Once the cord is connected to the bath, connect the other end to the main power source.

Approved Fluids

The only approved fluids for all Precision baths are:

Filtered/Single Distilled Water

De-ionized Water ¹

¹ For applications requiring resistivity greater than 1 MΩ-cm or maintaining resistivity levels greater than 1 MΩ-cm please call and speak to an applications engineer for additional information.

Thermo Fisher Scientific takes no responsibility for damages caused by using an unapproved fluid.



When using water above 80°C closely monitor the fluid level, frequent top-offs will be required. It will also create steam.

Filtered/Single Distilled Water

Filtered drinking water and single distilled water are good choices for heated water baths. The filtering/distilling process removes microorganisms that are known to cause biological fouling in water baths. The filtering/distilling process also removes minerals and harmful particulates from water. Microorganisms, minerals and particulates can lead to deposits and or scaling that eventually promotes corrosion if not removed or treated.

It is also recommended to regularly drain and replace fluid especially when higher temperatures are utilized (above 40°C). Draining and drying the bath after each use is recommended as leaving standing water for any period of time is known to lead to a buildup of biologic growth.

Tap Water

Usage of tap water may not cause any adverse affects on the equipment in the short term, but in the long term problems may arise due to precipitation of minerals and or development of algae and bacteria. Please refer to “Process Water Quality and Standard” recommendations in this chapter for guidelines on water usage.

Chlorine

Draining and replacing “used” water is the best preventative maintenance for the cooling/heating equipment. Biological organisms will develop in water that is not replaced or treated regularly. A mild treatment using an algaecide can help extend the useful life of water.

To help alleviate bacteria or algae growth Thermo Fisher Scientific recommends the use of small amounts of chlorine. The usage of chlorine needs to be monitored over time in order to prevent the formation of corrosion.

The duration of time that chlorine remains in solution depends on factors such as water temperature, pH and availability of direct sunlight. We recommend maintaining chlorine levels

at 1 to 5 ppm free chlorine. PPM levels can be monitored using standard water quality test strips. For best results, maintain the pH of the fluid between 6.5 and 7.5.

Do not add additional chlorine without first determining the concentration ratio that already exists in the fluid supply. Corrosion and degradation of the circulation components can result from concentration ratios that are too high. Contact our customer support for additional information.

De-ionized Water

De-ionized water is water that has had its mineral ions removed using ion exchange resins. The purpose of this process is to remove the ions that allow electrical current to flow more easily through water. This helps to prevent electrical leaks to ground through the recirculating fluid. De-ionized water is in an unbalanced state and will leach the missing ions from the materials it comes in contact with. The aggressive nature of this leaching can cause pitting on metal surfaces. Note that the de-ionizing process does not remove microorganisms. Because of this, we recommend de-ionized water only with applications that have it as a specified requirement. In any case, only de-ionized water with 1 MΩ-cm resistivity, or less, is recommended.

Recommended Biocides and Inhibitors

Thermo Fisher Scientific offers a biocide and inhibitor package Thermo 200 (Nalco) premixed with five gallons of water or as a kit to be added to water.



Biocides are corrosive and can cause irreversible eye damage and skin burns. They are harmful if inhaled, swallowed or absorbed through the skin. Refer to the manufacturer's most current MSDS.

Thermal Beads (GP Baths only)

GP baths can use thermal beads. The beads replace water to reduce the risk of contamination.

Water Quality and Standards		
Process Fluid	Permissible (PPM)	Desirable (PPM)
Microbiologicals		
(algae, bacteria, fungi)	0	0
Inorganic Chemicals		
Calcium	<25	<0.6
Chloride	<25	<100
Copper	<13	<10
	0.020 ppm if fluid in contact with aluminum	
Iron	<0.3	<0.1
Lead	<0.015	0
Magnesium	<12	<0.1
Manganese	<0.05	<0.03
Nitrates/Nitrites	<10 as N	0
Potassium	<20	<0.3
Silicate	<25	<1.0
Sodium	<20	<0.3
Sulfate	<25	<1
Hardness	<17	<0.05
Total Dissolved Solids	<50	<10
Other Parameters		
pH	6.5-8.5	7-8
Resistivity	0.01*	0.05-0.1*

* MΩ-cm (compensated to 25°C)

Unfavorably high total ionized solids (TIS) can accelerate the rate of corrosion. These contaminants function as electrolytes which increase the potential for galvanic cell corrosion.

Tap water is not normally recommended because the total ionized solids level may be too high. As an example, tap water in the United States averages 171 ppm (of NaCl). The recommended level for use in a water system is between 0.5 to 5.0 ppm (of NaCl).

Filling Requirements

Ensure the reservoir drain port is closed and that all plumbing connections are securely plumbed or capped. Also ensure any residue is thoroughly removed from the reservoir before filling.

To avoid spilling, place your samples/trays into the bath before filling. Also make allowance for splashing of water from tray oscillation movement.

Slowly fill the reservoir. When adding, point the opening of a container away from yourself.

For Shaking Water Baths, fill the reservoir with a minimum of one inch and the maximum level lower than the tray shaft fitting.

For Circulating and Coliform Baths, fill the reservoir with a minimum of two inches, ensuring the suction screen is covered, and a maximum level one inch lower than the upper tank surface.

For General Purpose Baths, fill the reservoir with a minimum of one inch and a maximum level one inch lower than the tank upper surface.

Note Monitor the fluid level whenever heating the fluid.

To conserve energy, reduce evaporation, and increase temperature control accuracy, use the supplied gable cover. Do not use aluminum foil as a cover, as it may cause corrosion due to an electrochemical reaction.

Filling with Thermal Beads (GP baths only)

Use the controller to configured the bath before using the thermal bead mode, see Chapter 4 Changing a Setting.

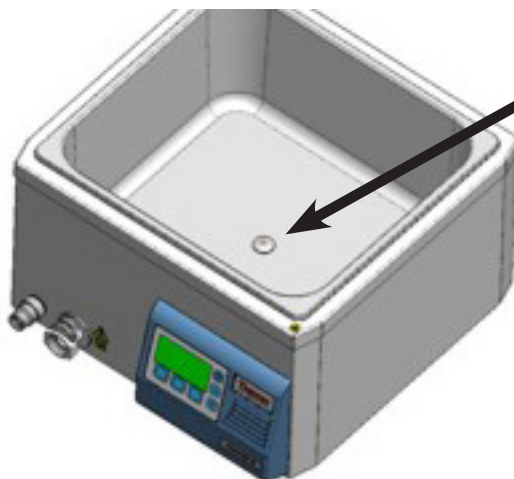

Figure 3-2– Thermal Beads Reservoir Plug

Before filling the reservoir with beads ensure the supplied reservoir plug is securely installed into the drain.

Note For safety considerations, enabling the mode automatically derates the bath's heater performance, and it turns off low fluid protection so the beads don't trip the alarms.

This mode also derates the bath's stability and uniformity capability.



Draining

Drain the bath before moving or storing.

Ensure the fluid is at a safe handling temperature, ~40°C or lower. Wear protective clothing and gloves.

- Place a suitable receptacle underneath the drain.
- Slowly turn the drain plug until flow is observed.
- When the flow stops close the drain plug.

Draining (GP 10, GP 20, GP 28 and GP 15D only)

- Remove the drain hose from its housing and insert the fitting into the drain quick disconnect.
- When the flow stops remove the hose and reinsert it back into the housing.



Figure 3-3– GP Bath Drain Hose

Accessories



Only use the accessories supplied by Thermo Fisher.

Drain Kit Accessory

- Before filling the bath remove the drain plug from the bath drain.
- Wrap coupler with Teflon[®] tape, or equivalent, and install into bath drain.
- Insert quick disconnect into hose.
- To start draining snap quick disconnect onto coupler.
- To remove quick disconnect from coupler and stop draining press down on the disconnect's grey release.

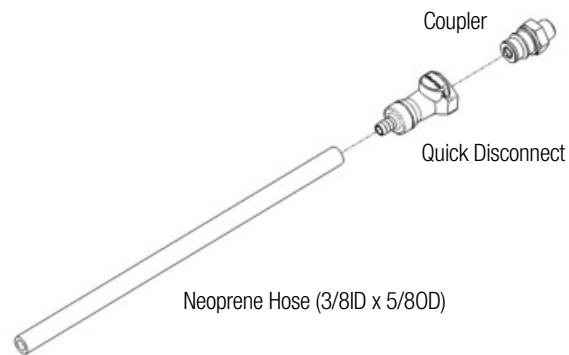

Figure 3-4—Drain Kit Accessory

4

Chapter 4 Operation

Controller

The Thermo Scientific Precision Water Baths have digital controllers that display the bath's reservoir fluid temperature, shaker speed and other bath features.

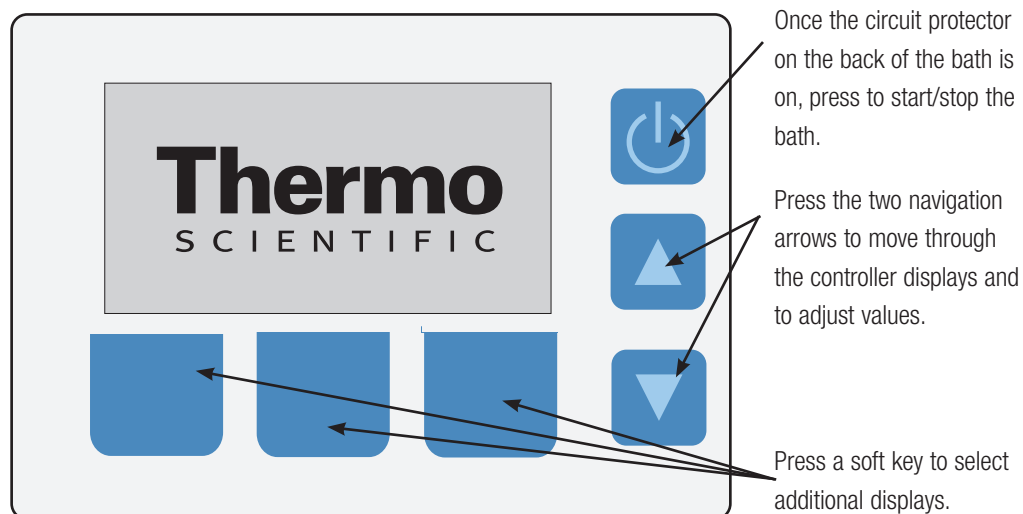

Indicates the heater is on. The icon flashes when the reservoir fluid temperature is near or at the set point.



Indicates the timer is enabled. The timer is used to turn the bath on, off, or both.



Indicates the audible alarm status, enabled or disabled.



Indicates the shaker mode is enabled, SWB only.



Indicates the pump is running. This icon is always on once the bath is running. Circulating and Coliform Baths only.

Start Up



Before starting, double check all electrical connections.



An operating Shaker Water Bath has moving components. Do not insert appendages between the reservoir wall and rack. We recommend stopping the shaker table when loading/removing samples or vessels.



For Shaking Water Baths ensure all glass vessels are secure. Unrestrained vessels may shift and break when shaking is engaged. Flask clips and trays are available from Thermo Fisher.

Do not run the bath until fluid is added to the reservoir. Have extra fluid on hand. If the bath does not start refer to Chapter 6 Troubleshooting.

- Place the circuit protector located on the rear of the bath to the I position.
- The screen will momentarily display **Thermo** and then the home screen appears displaying the set point and the audible alarm status. The set point is the desired reservoir fluid temperature.

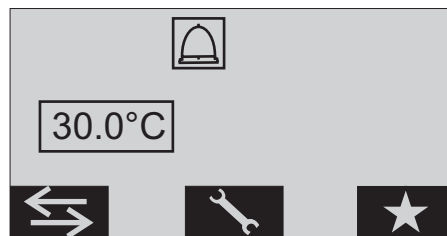
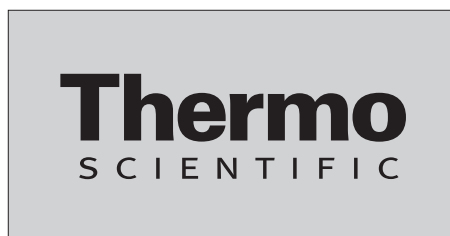

- Press  to start the bath and display the reservoir fluid temperature. If the fluid temperature is below the set point the heater will start.

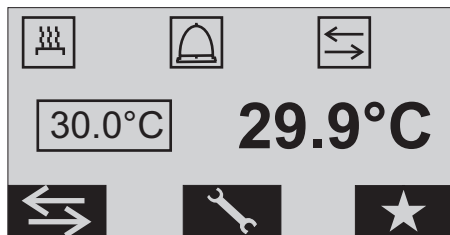



 appears on Shaking Water Baths only.

Viewing/Changing the Shaker Speed (SWB only)

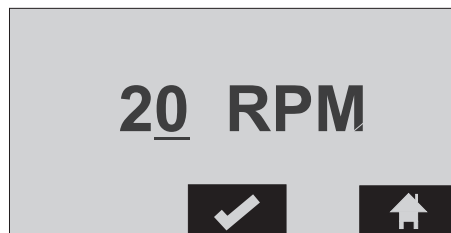
You can view/change the shaker speed value with the bath running or not. From the home screen press the soft key below  to display:



Press, and hold, the arrow keys to bring up the desired value. The values are 0 and 30 to 200.

Once the desired value is displayed press  or  to save the change and return to the home screen.

Changing the Set Point

Note This procedure applies to Shaker, Circulating and General Purpose Baths only.



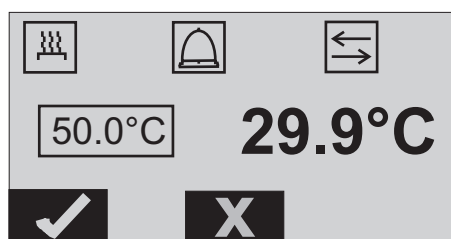

When operating without a lid, limit the maximum set point to 60°C.

The set point is the desired reservoir fluid temperature. You can change the set point with the bath running or not. From the home screen press either arrow key to display:



Press, and hold, the arrow keys to bring up the desired set point value. The range is 5°C to 100°C.

Once the desired value is displayed, in this case 50.0°C, press the soft key below  to save the change or press the soft key below  to not save the change. The display returns to the

home screen. **Note** After a 30 second delay if neither key is pressed the display returns to the home screen, any change is *not* saved.

Selecting a Preset Set Point

The set point is the desired reservoir fluid temperature. You can select the set point with the bath running or not. Or, from the home screen press .

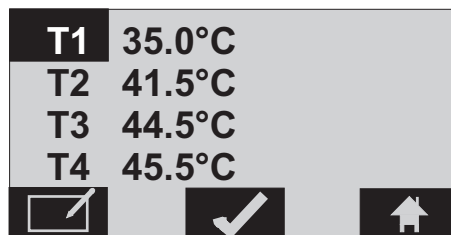

Use the arrow keys to select the desired set point value. Once the desired set point is highlighted press the soft key below  to save the change and return to the home screen.

Note After a 30 second delay if neither key is pressed the display returns to the home screen, any change is *not* saved.

Note From the home screen you can cycle through the set points by pressing the arrow keys (Coliform baths only).

Changing a Setting

Press the soft key below  to display the Setting screen.

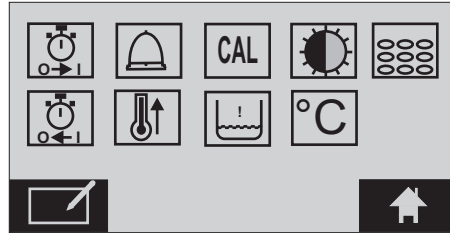

 appears on General Purpose Baths only.

Use the arrow keys to highlight the desired setting. Press

 to make changes.





These icons represent the timer. The top one is used to set the amount of time required, in hours and minutes, before the bath will start. The bottom is used to set how long the bath will run, in hours and minutes, before shutting down. When the bath starts/stops the alarm, if enabled, will beep.

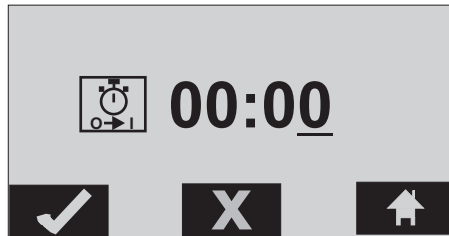

Once the desired timer mode is selected press, and hold, the arrow keys to change the time.



Once the desired value is displayed press  to save the change or  to reset the time to zero. Press  to return to the home screen.

The timer can be used to turn the bath on and then, at a later time, turn the bath off. (Or turn a running



bath off and then back on.) The bath off time must take into account the start time value. For example, if you want the bath to start in 60 minutes and then turn it off 30 minutes later, set the start time to 1:00 and set the off time to 1:30.

Note You cannot set a start time if the bath is running or set an off time if the bath is not running.



These icons represent the audible alarm status. The top indicates it is enabled, the bottom indicates disabled. Press  to toggle between enabled/disabled. Use the arrow keys to highlight another setting or press



 to return to the home screen. Press, and hold, an arrow key to change the temperature. Once the desired value is displayed press  to save the change or  to not save the change.



This icon represents the high temperature alarm. If the reservoir fluid exceeds this temperature the bath will shut down and, if enabled, the alarm will sound. The controller will also have an error display, .

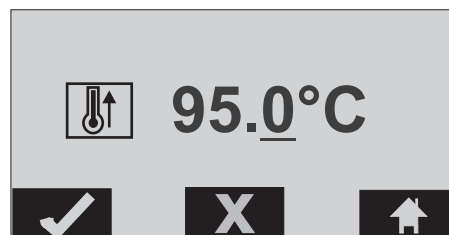





Press  to return to the home screen.

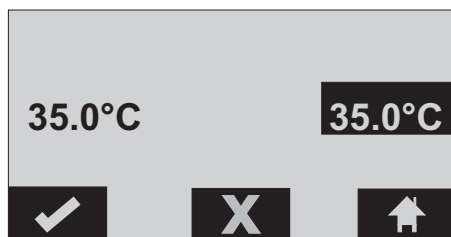

This icon is used to do a reservoir fluid temperature sensor 2-point calibration. The procedure requires a calibrated reference thermometer. Except for Coliform Baths, before the calibration can be performed the fluid temperature must be stabilized at 35°C and then again at 70°C, 35°C and then again at 55°C for Coliform Baths (the sequence does not matter).



Note Performing a calibration at any other temperatures will result in an error display .



Once the temperature has stabilized at 35°C, or 70°C (55°C), press  then use the arrow key to change the temperature to match the reference thermometer. Once the desired value is displayed press  to save the change or  to not save the change.

Press  to return to the home screen. Repeat the procedure for the other temperature.





These icons represent the low fluid protection status. The top indicates it is enabled, the bottom is disabled. Press  to toggle between enabled/disabled. Press  to return to the home screen.

When enabled and the reservoir level nears empty the bath will shut down and, if enabled, the alarm will sound. The controller will also have an error display, .



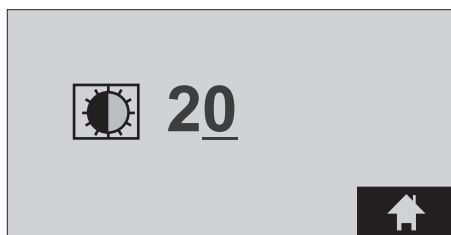

This icon is used to adjust the display's contrast.



Press, and hold, an arrow key to change the contrast. Once the desired contrast is displayed press  to return to the home screen.



These icons are used to select the desired temperature scale, °C or °F. Press  to toggle between °C and °F. Press  to return to the home screen.



GP bath reservoirs can be filled with thermal beads instead of water. These icons are used to select/deselect the reservoir bead mode.



Press  to toggle between on and off. **Note** For safety considerations, the mode automatically derates the bath's heater performance, and it turns off low fluid protection so the beads don't trip the alarms. This mode also derates the bath's stability and uniformity capability.

Press  to return to the home screen.

Selecting a Preset

Four presets are available. Press the soft key below  to display the Presets screen.

Note RPM appears on Shaker Water Baths only.



T1	35.0°C	30 RPM
T2	37.0°C	50 RPM
T3	50.0°C	70 RPM
T4	55.0°C	90 RPM
		

To select the desired preset use the arrow keys to highlight it and then press . The home screen will appear with the desired preset set point value.





Changing a Preset

Note Changing a preset does not automatically select it. Once a change is made you will have to return to the Preset screen and follow the **Selecting a Preset** procedure.

Press the soft key below  to display the Presets screen. **Note RPM** appears on Shaker Water Baths only.

T1	35.0°C	30 RPM
T2	37.0°C	50 RPM
T3	50.0°C	70 RPM
T4	55.0°C	90 RPM
		

To change a preset first highlight it using the arrow keys and then press .

	T1:35.0°C	
CAL	RTA1 0.0°C	
	30 RPM	
		

Press the arrow keys to highlight the desired preset parameter and press  again. Then press, and hold, the arrow keys to change the value.

Once the desired value is displayed press .

If desired, press the arrow keys to highlight another preset parameter or press  to return to the home screen.

Changing the Real Time Adjustment (CAL RTA) requires a calibrated reference thermometer. If the displayed temperature does not accurately reflect the actual temperature in the reservoir an RTA value is required.

As an example, if the temperature is stabilized and displaying 20°C but a calibrated reference thermometer reads 20.5°C, set the RTA to -0.5°C. After you enter an RTA value allow the display to stabilize before verifying the bath temperature.

Note The RTA applies only to the selected preset.

Temperature Display

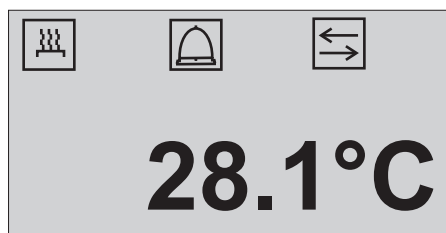

With the bath running, and after 30 seconds, if none of the keys are pressed, the controller will display only the reservoir fluid temperature and any active feature. Press any key to return to the previously displayed screen.

Shut Down

- Press  to stop the bath heating and, if applicable, shaking.

Note Pressing and holding  for three seconds stops the heating and powers down the controller display. Press  to turn the display back on.

- For bath shut down place the circuit protector located on the rear of the bath to the **0** position.
- To disconnect the bath remove the electrical plug from its power source.

5

Chapter 5 Preventive Maintenance



Disconnect the power cord prior to performing any maintenance.



Handle the bath with care, sudden jolts or drops can damage its components.

Pump Inlet Filter (Circulating and Coliform baths only)

The filter on the pump inlet protects the pump from foreign materials. Since applications vary, monitor the filter to establish your cleaning/replacement schedule.

Cleaning

Clean the bath's surface with a soft cloth and warm water only.

Clean the reservoir and built-in components at least every time the bath liquid is changed.

Before cleaning the bath's surfaces, to protect labels, the nameplate, electrical connections, painted and plastic surfaces and to prevent the cleaning agent from entering through any vent openings, mask off all areas except the reservoir.

After time, the circulating bath's stainless steel surfaces may show spots and become tarnished. Normal stainless steel cleaners can be used.



Do not use scouring powder or any substance containing solvents.

The inside of the bath must be kept clean in order to ensure a long service life. Quickly remove substances containing acidic or alkaline substances and metal shavings as they could harm the surfaces causing corrosion. If corrosion (e.g., small rust marks) occur in spite of this, cleaning with stainless steel caustic agents has proved to be suitable. Apply these substances according to the manufacturer's recommendations.

Electrical Power Cord

Ensure any replacement cord is properly rated.

Optical Disc (SWB only)

Check the optical disc monthly and verify it is free of foreign material. If not, wipe the disc clean.

1. Remove the four screws, two on top and two on the side securing the top right panel.
2. Swing panel assembly open.



Do not operate the bath with the panel open.

3. Rotate disc, by grasping aluminum components of the eccentric only, one turn clockwise and verify that disc does not rub against optical sensor. If required, use the 3/32" Allen to loosen two set screws on the eccentric and reposition the disc.

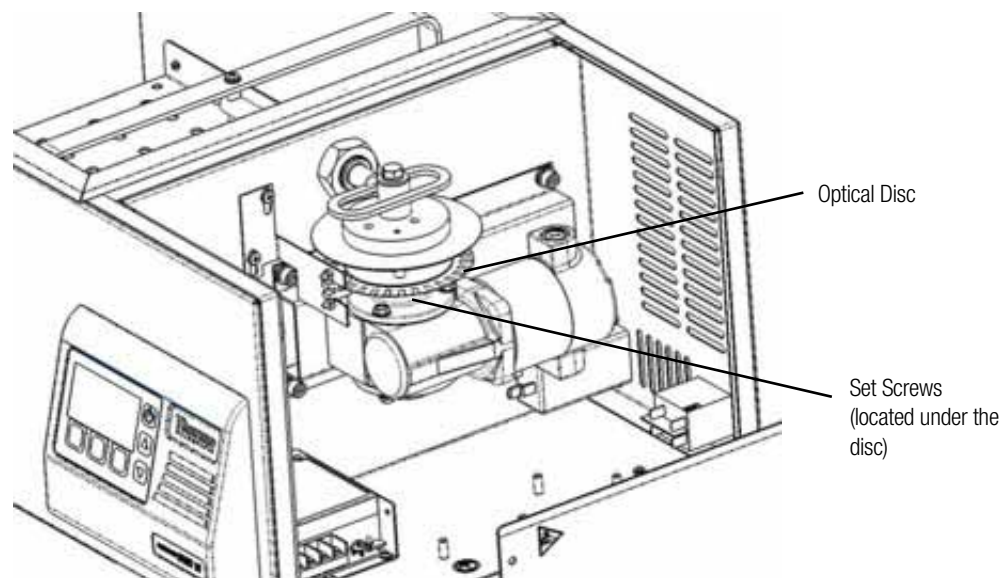

Shaker Assembly

Check the shaker assembly for looseness annually. Contact Fisher Scientific if excessive movement is noted.





6

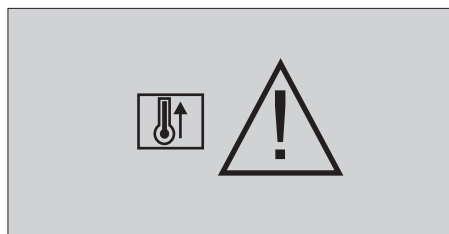

Chapter 6 Troubleshooting

Error Displays

An error display indicates an unusual condition. With any message, except **CAL**, the bath will stop heating and, if applicable, the pump will stop. With any message the alarm, if enabled, will sound.



Display	Cause/Action
	HTC Fault fixed high temp protection limit exceeded allow bath to cool down restart the bath if the HTC fault cannot be cleared, the bath must be serviced by an authorized Thermo Scientific Temperature Control Service Technician.
	High Temp Fault adjustable high temp fault protection limit exceeded check limit setting
	Low Fluid Level low level protection limit exceeded check fluid level check for leaks
	Open/Shorted Internal Temp Sensor the bath must be serviced by an authorized Thermo Scientific Temperature Control Service Technician.

Display	Cause/Action
	<p>Bad Calibration</p> <p>redo calibration</p> <p>ensure calibration set points are 35.0°C and 70.0°C (35.0°C and 55.0°C for Coliform Baths)</p>
	<p>Shaker Malfunction (SWB only)</p> <p>ensure there is nothing in the reservoir hampering shaker movement.</p> <p>the bath must be serviced by an authorized Thermo Scientific Temperature Control Service Technician.</p>

Checklist

Bath will not start or shuts down

- Check display for error messages.
- Ensure  wasn't accidentally pressed.
- Ensure the circuit protector is in the on (I) position.
- Check the line cord connection to your power supply and at the bath.
- Make sure supply voltage is connected and matches the bath's nameplate rating $\pm 10\%$.
- Restart the bath.

No display

- Pressing  should return the display.
- Cycle the bath's circuit protector.

Inadequate temperature control

- Verify the set point.
- Low-end temperature set points require supplemental cooling.
- GP 02 baths require insulation, especially in the lid, for operation above 90°C.
- Ensure bath installation complies with the site requirements in Chapter 3.
- Make sure supply voltage matches bath's nameplate rating $\pm 10\%$.

Please contact Thermo Fisher Scientific Sales Service and Customer Support if you need any additional information, see inside cover for contact instructions.

Warranty

Thermo Fisher Scientific warrants products for 24 months from date of shipment according to the following terms.

Any part of the bath manufactured or supplied by Thermo Fisher Scientific and found in the reasonable judgment of Thermo Fisher to be defective in material or workmanship will be repaired at an authorized Thermo Fisher Repair Depot without charge for parts or labor. The bath, including any defective part must be returned to an authorized Thermo Fisher Repair Depot within the warranty period. The expense of returning the bath to the authorized Thermo Fisher Repair Depot for warranty service will be paid for by the buyer. Our responsibility in respect to warranty claims is limited to performing the required repairs or replacements, and no claim of breach of warranty shall be cause for cancellation or rescission of the contract of sales of any bath. With respect to baths that qualify for field service repairs, Thermo Fisher Scientific's responsibility is limited to the component parts necessary for the repair and the labor that is required on site to perform the repair. Any travel labor or mileage charges are the financial responsibility of the buyer.

The buyer shall be responsible for any evaluation or warranty service call (including labor charges) if no defects are found with the Thermo Scientific product.

This warranty does not cover any bath that has been subject to misuse, neglect, or accident. This warranty does not apply to any damage to the bath that is the result of improper installation or maintenance, or to any bath that has been operated or maintained in any way contrary to the operating or maintenance instructions specified in this User Manual. This warranty does not cover any bath that has been altered or modified so as to change its intended use.

In addition, this warranty does not extend to repairs made by the use of parts, accessories, or fluids which are either incompatible with the bath or adversely affect its operation, performance, or durability.

Thermo Fisher Scientific reserves the right to change or improve the design of any bath without assuming any obligation to modify any bath previously manufactured.

THE FOREGOING EXPRESS WARRANTY IS IN LIEU OF ALL OTHER WARRANTIES, EXPRESSED OR IMPLIED, INCLUDING BUT NOT LIMITED TO WARRANTIES OR MERCHANTABILITY AND FITNESS FOR A PARTICULAR PURPOSE.

OUR OBLIGATION UNDER THIS WARRANTY IS STRICTLY AND EXCLUSIVELY LIMITED TO THE REPAIR OR REPLACEMENT OF DEFECTIVE COMPONENT PARTS AND Thermo Fisher Scientific DOES NOT ASSUME OR AUTHORIZE ANYONE TO ASSUME FOR IT ANY OTHER OBLIGATION.

Thermo Fisher Scientific ASSUMES NO RESPONSIBILITY FOR INCIDENTAL, CONSEQUENTIAL, OR OTHER DAMAGES INCLUDING, BUT NOT LIMITED TO LOSS OR DAMAGE TO PROPERTY, LOSS OF PROFITS OR REVENUE, LOSS OF THE BATH, LOSS OF TIME, OR INCONVENIENCE.

This warranty applies to chillers sold by Thermo Fisher Scientific. (Refer to the warranty for baths sold by the affiliated marketing company of Thermo Fisher Scientific for any additional terms.) This warranty and all matters arising pursuant to it shall be governed by the law of the State of New Hampshire, United States. All legal actions brought in relation hereto shall be filed in the appropriate state or federal courts in New Hampshire, unless waived by Thermo Fisher Scientific.

thermoscientific.com

© 2015 Thermo Fisher Scientific Inc. All rights reserved. All trademarks are the property of Thermo Fisher Scientific Inc. and its subsidiaries. Specifications, terms and pricing are subject to change. Not all products are available in all countries. Please consult your local sales representative for details.

Thermo Fisher Scientific
81 Wyman Street
Waltham, MA 02451

Thermo
SCIENTIFIC
A Thermo Fisher Scientific Brand